

SONY®



HD

HD Visual Communication Systems

PCS-XG55

PCS-XG55S

IPELA™

Stunning video and audio brought to you by the "IPELA" series of visual communication products that encompass the three-pronged concept of "Reality," "Intelligence," and "Usability." "IPELA" is the identity symbolizing the Sony vision for the workplace of the future, connecting people, places, and information with reality that has never before been achieved. "IPELA" lets you share, understand, and experience as if you are actually there, when in fact, you are miles away. It allows you to quickly grasp a situation to make better business decisions.

Real audiovisual communication over networks – this is business communication of the future, this is business communication brought to you today, this is "IPELA."

Reality

- Stunning HD Video (1280 x 720p)
- Superb Sound (MPEG-4 AAC Stereo)

Intelligence

- BrightFace Technology (PCSA-CXG80)
- Enhanced Intelligent QoS Function

Usability

- Video Annotation Function
- "One-touch Dialing" With RF Remote Commander Unit
- Single Connection with HDMI Cable

Powerful and Compact PCS-XG55 HD Visual Communication System Brings You New Business Communication Style

Sony, a leader in the AV industry, introduces a powerful new addition to its high-definition (HD) visual communication lineup, the PCS-XG55. Powerful, affordable, and compact, the PCS-XG55 achieves 720p HD video quality with a maximum frame rate of 60 fps, making your style of everyday business communication more effective, productive, and comfortable.

What's more, the HD camera of the PCS-XG55 adopts Sony-developed BrightFace™ technology, which produces clear images even when used in rooms with less-than-ideal lighting conditions. The unit also features clear and natural sounding stereo audio, allowing you to hold stress-free videoconferences with "real communication" as if you were talking in the same room.

To make videoconferencing a powerful mainstream business communication tool, the PCS-XG55 has been designed to be extremely user-friendly. With an intuitive Graphical User Interface (GUI) that employs a simple layer structure and translucent cascading menus, the system makes videoconferencing easier. Moreover, the PCS-XG55 offers a number of other features for user convenience, such as a one-touch dialing feature for starting a videoconference, an HDMI interface allowing a single cable connection between the codec and display, and stress-free operation using the RF Remote Commander™ unit. You can also enhance the quality of your videoconferences with effective data sharing (video and presentation data from a PC) because the PCS-XG55 complies with the ITU-T H.239 standard*1. Presentation data can be transferred at a frame rate as high as 30 fps, which makes it possible to present animations during a videoconference. Moreover, by using the video annotation function*2 of the PCS-XG55, you can clearly point out specific parts of an image by writing on a tablet. With these outstanding data-sharing tools, you can now minimize misunderstandings during your videoconference.

With excellent HD video quality in a stylish and compact design, the PCS-XG55 takes your visual communications to the next level.

*1 Requires optional software.

*2 Requires an optional third-party pen tablet.

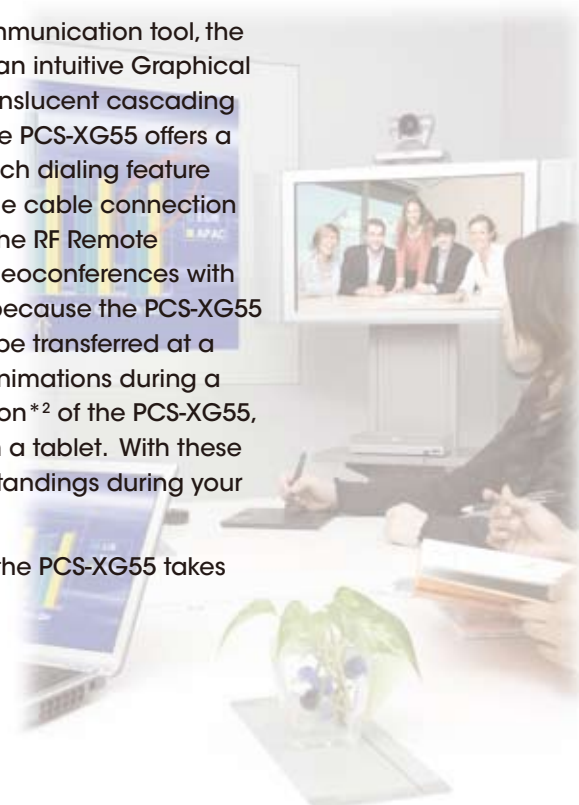

Reality

Stunning 720p High-definition (HD) Images

The PCS-XG55 adopts the H.264 video codec, which enables efficient transmission of high-quality images at up to 60 fps in a high-definition resolution of 1280 x 720 pixels. Stunning HD video enhances your videoconferencing with lifelike images for effective communication.

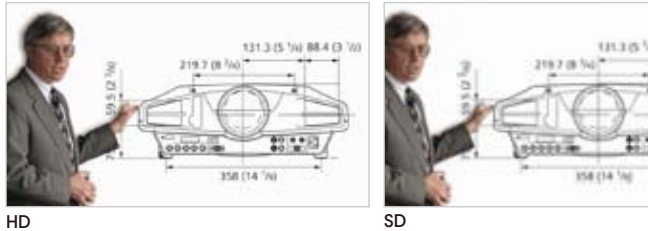

(Simulated images)

Superb Audio Quality

The PCS-XG55 produces clear and natural stereo sound, using the MPEG-4 AAC compression format. Since the unit has a built-in stereo echo canceller, which eliminates the annoying echo often heard with other systems, communication sounds far more natural.

ITU-T H.239 Support - Presentation Data Transferred at 30 fps*1

With support for the ITU-T H.239 (video and presentation data) standard, the PCS-XG55 can send both the video and presentation data displayed on your PC to videoconferencing counterparts for more effective communication. Presentation data can be transferred at frame rates as high as 30 fps*1, providing natural and smooth presentations even when using animation effects or showing videos from your PC. This presentation data can also be shown either from a projector or a sub display, using the RGB output.

*1 Requires optional software. These functions are available except when using the 720/60p video formats.

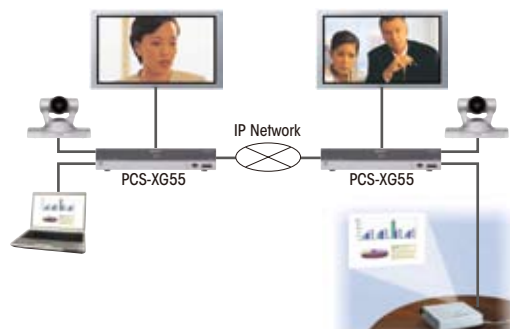

Intelligence

BrightFace Technology (PCSA-CXG80)

The PCS-XG55 has a dedicated HD camera (the PCSA-CXG80) that adopts Sony's unique BrightFace technology. This technology optimizes the brightness of each pixel to highlight shadows, while subduing areas of the image that are too bright, allowing operation in less-than-ideal lighting conditions. BrightFace technology can provide clear images even in dimly lit rooms, for example when using a projector, or in rooms with poor backlighting.



With BrightFace Function



Without BrightFace Function

(Simulated images)



Stable and Secure Videoconferencing

Enhanced Intelligent QoS™ Functions to Achieve Stable Transmission

To handle the transmission of large amounts of HD video data, while maintaining high-quality and stable communication over an IP network, the PCS-XG55 incorporates the following advanced Quality of Service (QoS) functions:

- Adaptive FEC (Forward Error Correction)
- Real-time ARQ™ (Automatic Repeat reQuest)
- ARC (Adaptive Rate Control)

These functions work in harmony for fast and consistent data throughput during the transmission of video signals, by adapting to any changes in the network condition and correcting any packet loss. For more information on the intelligent QoS mechanism, please refer to the Technical Note insert.



With Enhanced Intelligent QoS



Without Enhanced Intelligent QoS

(Simulated images)

Advanced Encryption Standard (AES) for High Security

Secure videoconferencing over a network is possible because the PCS-XG55 supports 128-bit AES encryption. The system's encryption complies with the ITU-T H.233/H.234/H.235 standards, which allow encrypted communication with other compliant systems. When the encryption mode is active, video, audio, and presentation data are encrypted for the duration of the videoconference.

Technical Note – Intelligent QoS Functions

Sony has implemented a number of QoS functions in all of its currently available visual communication systems. However, conventional QoS methods used with SD systems are inadequate when handling large amounts of data associated with high-definition (HD) video. Therefore, Sony has designed and implemented enhanced intelligent QoS functions in its HD visual communication systems.

Two major improvements have been made on the previous methods. First, the system intelligently allocates the amount of ARQ, FEC, and video data based on the bandwidth available, which is determined by the ARC function. Second, FEC is performed with larger FEC blocks and the number of parity packets are adjusted as required. This combination is both efficient and effective for transmitting large amounts of data over IP networks to help maintain high picture quality.

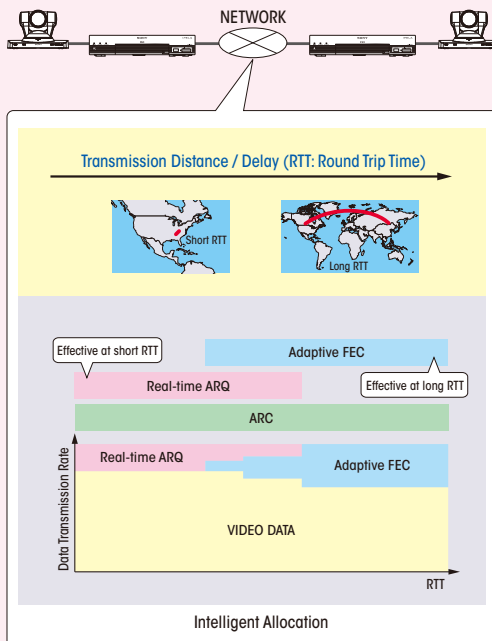

Usability

Video Annotation Function *2

For effective communication, the PCS-XG55 offers a useful video annotation function. Conference participants can clearly point out specific parts of shared data, including live images and presentation data, by simply writing on a tablet. This function can help you minimize time and effort in your communications, enabling you to deliver a clear, strong message.

*2 Requires an optional third-party pen tablet.



(Simulated images)

Multiple Display Layout

The PCS-XG55 has multiple display layouts such as Full Screen, Picture-in-Picture, Picture-and-Picture, and a Side-by-Side split screen. Any of these flexible display patterns can be selected so that both videoconferencing images and presentation data can be displayed in a manner that is effective and pleasing to the eye.

Simple Setup and Easy Operation Intuitive GUI - Simple Layer Structure/ Translucent Cascading Menus

The PCS-XG55 was thoughtfully designed with an intuitive GUI, utilizing translucent cascading menus. The simple layer structure and easy functionality allow you to operate the videoconferencing system, including the camera, much more easily.



(Simulated image)

"One-touch Dialing" With the RF Remote Commander Unit

For user convenience, the PCS-XG55 adopts an RF Remote Commander unit which you do not have to point directly towards the system. What's more, the PCS-XG55 has a convenient one-touch dialing feature, which allows you to easily connect to any of your registered contacts by just pushing a function button on the RF Remote Commander unit that corresponds to a thumbnail image on the GUI. Up to four contacts for one-touch dialing can be shown on the home menu from a maximum of 1,000 registered contacts.



"One-touch Dialing" With Newly
Designed RF Remote Commander Unit

(Simulated image)

Single Cable Connection With HDMI

With the supplied HDMI cable, the PCS-XG55 can be connected to an HDMI-equipped display. This single cable transmits both audio and video, allowing the codec and display to be neatly and quickly wired.

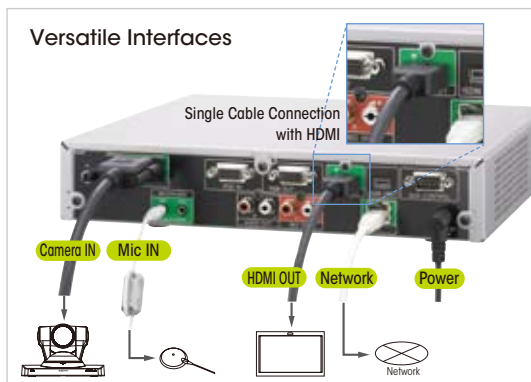

Backward Compatibility With SD Systems

Since the PCS-XG55 is backward compatible with legacy SD systems, you can seamlessly integrate the system into your existing standard-definition videoconferencing environment. This enables you to migrate from SD to HD at your own pace, with minimal upfront investment.

Compact and Stylish Design Suitable for a Variety of Meeting Rooms

With its compact and stylish design, the PCS-XG55 fits neatly into boardrooms, medium- and small-sized meeting rooms, and even classrooms. Since the compact and powerful HD videoconferencing system is incredibly light in weight at approximately 2.0 kg (4 lb 3 oz), system integrators find it easy to install.

Other Features

- Memory Stick™ recording - video/presentation data (including annotations) and audio can be recorded for later review
- Presentation data can be sent as a single stream by selecting the RGB input
- Built-in streaming function for multicasting to large audiences
- Support for IPv6
- Support for H. 460 Firewall Traversal
- Up to 100 camera preset positions can be stored, each with a thumbnail image for easy recall

Videoconferencing for Our Environment

You can help reduce CO₂ emissions and support our environment by using videoconferences in lieu of business travel. Sony HD visual communication systems can make you feel as if you are communicating in the same room. Stay in touch, travel less, and save our earth. Sony has an answer.

Peripheral Equipment



PCS-XG80
HD Visual Communication System



PCSA-CXG80
1/3-Type CMOS HD Camera
(PCSA-CXG80 is supplied with the PCS-XG55.)



EVI-HD1
1/3-Type CMOS HD Camera



BRC-H700
1/3-Type 3CCD HD Camera



BRC-Z700
1/4-Type 3CMOS HD Camera

Optional Accessories



PCS-A1
Omnidirectional Microphone
(One PCS-A1 mic is supplied with the PCS-XG55.)



PCSA-A3
Unidirectional Microphone



PCSA-DSG80
HD Data Solution Software
(for H.239 video and presentation data)



PCSA-B768S
ISDN I/F Box 768Kbps



PCSA-B384S
ISDN I/F Box 384Kbps

Sample System Configurations

System configuration when using PCS-XG80 systems as parents

HD Videoconferencing

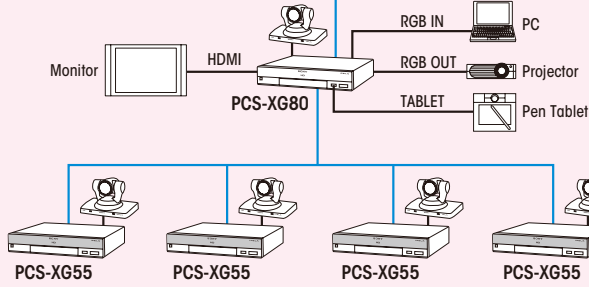

HD Videoconferencing

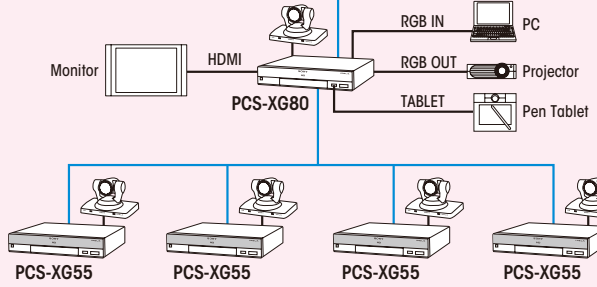

Connector Panels

Front

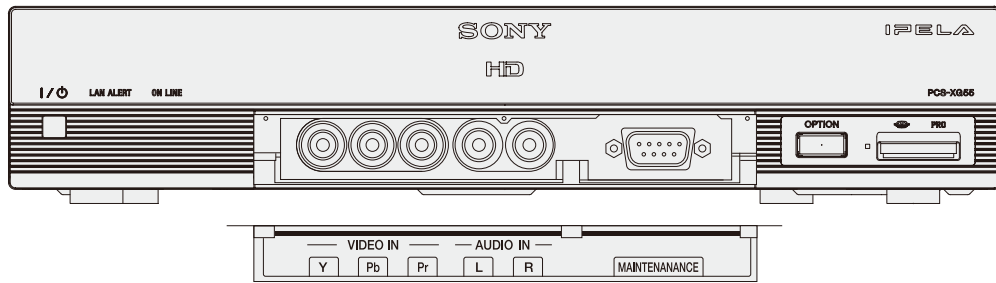

Rear

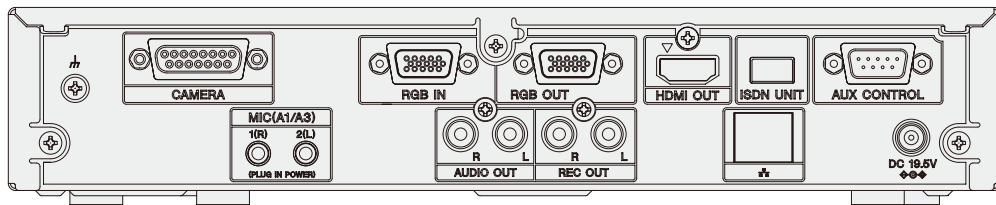

Dimensions

PCS-XG55S

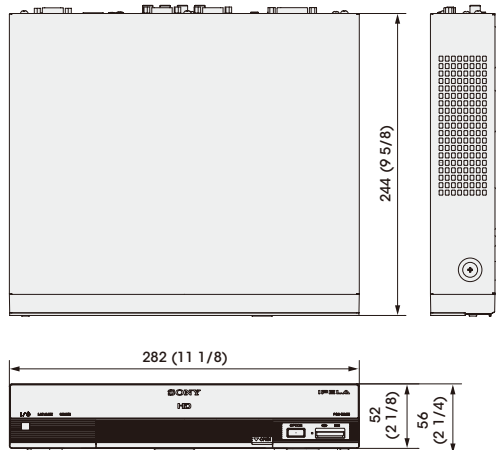

PCSA-CXG80

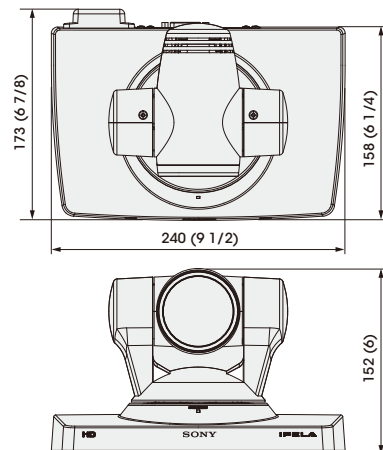

Unit: mm (inches)

Specifications

HD Codec Unit

PCS-XG55	
Video	
Communication protocol standards	H.320, H.323, IETF SIP
Compression standard	H.261, H.263, H.263+, H.263++, H.264, MPEG-4SP@L3 (SIP only)
Resolution	4:3 - QCIF (176 x 144), CIF (352 x 288), 4CIF (704 x 576) 16:9 - wCIF/w288p (512 x 288), w432p (768 x 432), w4CIF (1024 x 576), 720p (1280 x 720)
Maximum frame rate	Max. 60fps: H.264 - 720p Max. 30fps: H.261 - QCIF, CIF H.263 - QCIF, CIF H.264 - QCIF, CIF, 4CIF, wCIF, w432p, w4CIF Max. 10fps: H.263 - 4CIF
Bit rate	IP - 64 kb/s to 4 Mb/s ISDN - 56 kb/s to 768 kb/s (with optional PCSA-B768S), 56 kb/s to 384 kb/s (with optional PCSA-B384S)
Audio	
Bandwidth and coding	MPEG-4 AAC Stereo: 22 kHz at 192 kb/s (IP only) MPEG-4 AAC Mono: 14 kHz at 48 kb/s, 64 kb/s, 96 kb/s MPEG-4 AAC Mono: 22 kHz at 96 kb/s (IP only) G.711: 3.4 kHz at 56 kb/s, 64 kb/s G.722: 7.0 kHz at 48 kb/s, 56 kb/s, 64 kb/s G.728: 3.4 kHz at 16 kb/s
Echo cancellation	Stereo echo-canceling supported Noise reduction included Automatic gain control included
Network	
Protocol	TCP/IP, UDP/IP, RTP/RTCP, DHCP, DNS, TELNET, SSH, HTTP, SNMP, NTP, ARP, PPPoE, UPnP
QoS (Quality of Service)	Adaptive FEC, Real-time ARQ, ARC, IP Precedence, DiffServe
Others network features	NAT, UDP shaping, TCP/UDP port setting, Auto gatekeeper discovery, Packet reordering, IPv6
Standards	
ITU-T (excludes audio/video standards)	H.221, BONDING, H.225.0, H.231, H.241, H.242, H.243, H.245, H.350, H.460.18, H.460.19
IETF	RFC2190, RFC3016, RFC3047, RFC3261, RFC3264, RFC3550, RFC3984, RFC4573, RFC4587, RFC4629, RFC4856, RFC4628, RFC5168
Encryption	H.233, H.234, H.235 ver.3
Far end camera control	H.224, H.281
Screen Layout	
	Full screen, Picture-in-Picture, Picture-and-Picture, Side-by-Side split screen
Data Sharing	
	H.239 Video and Presentation Data*
Lip Synchronization	
	AUTO/OFF
Mic off Function	
	ON/OFF
Interface	
Video input	D-Sub 15-pin Dedicated Camera I/F x 1 Y/Pb/Pr x 1 RGB (D-sub 15) x 1
Video output	HDMI (video, audio) x 1 RGB x 1
Audio input	External analog microphone input Mini-jack (Plug in power) x 2 (L/R) Audio Input (MIC/AUX) x 1 (RCA pin, stereo)
Audio output	HDMI (video, audio) x 1 Line Output (RCA pin, stereo) x 1 REC Output (RCA pin, stereo) x 1
Memory stick	Memory Stick/Memory Stick Duo Slot x 1
Network	10BASE-T/100BASE-TX x 1
Control	RS-232C x 1
Maintenance interface	RS-232C x 1
Other interface	Tablet Interface x 1
General	
Operating temperature	5 to 35 °C (41 to 95 °F)
Operating humidity	20 to 80% (non condensing)
Storage temperature	-20 to 60 °C (-4 to 140 °F)
Storage humidity	20 to 80% (non condensing)
Power requirements	DC 19.5V (AC Adapter: AC 100 to 240 V, 50/60 Hz)
Power consumption	40 W (the unit only)/90 W (with PCSA-CXG80, PCSA-B768S)
Power consumption (stand-by)	10 W (the unit only)/15 W (with PCSA-CXG80, PCSA-B768S)
Dimensions (W x H x D)	282 x 56 (including rubber feet) x 244 mm (11 1/8 x 2 1/4 x 9 5/8 inches), excl. projections
Mass	Approx. 2.0 kg (4 lb 3 oz)
Supplied Accessories	
	AC adaptor, HDMI cable (3 m), RF Remote Commander Unit, Batteries for Remote Commander unit x 2, CD-ROM (Operating instructions, Before using this unit, Connection sheet, Quick dial guide, Important notice regarding software), Warranty booklet

* PC images up to SXGA resolution is supported.
It requires the optional HD data solution software PCSA-DSG80 to send video and presentation data simultaneously.

HD Camera Unit

PCSA-CXG80	
Image Device	1/3-type CMOS
Effective Picture Elements	Approx. 2 Megapixels (16:9)
Focal Length	3.4 to 33.9 mm (F1.8 to F2.1)
Focus	Auto/Manual
Horizontal Image Angle	Approx. 8° (tele) to 70° (wide)
Zoom Ratio	x 10 optical zoom (x 40 with digital zoom)
Pan/Tilt Angle	-100° to +100° (Pan), -25° to +25° (Tilt)
S/N	More than 50 dB
GAIN	AUTO
Control Out	VISCA OUT RS-232C for 2nd camera control
Position Preset	100 positions
Operating Temperature	5 to 35 °C (41 to 95 °F)
Operating Humidity	20 to 80% (non condensing)
Storage Temperature	-20 to 60 °C (-4 to 140 °F)
Storage Humidity	20 to 80% (non condensing)
Power Requirements	DC 19.5V (supplied via the codec)
Dimensions (W x H x D)	240 x 152 (including rubber feet) x 158 mm (9 1/2 x 6 x 6 1/4 inches), excl. projections
Mass	Approx. 2 kg (4 lb 3 oz)
Others	BrightFace function, Noise reduction, Backlight compensation, Auto white balance
Supplied Accessories	Camera cable (3m), Hook-and-loop pads x 2, Operating instructions, Warranty booklet

Package Configuration

	PCS-XG55	PCS-XG55S
HD Codec Unit (PCS-XG55S)	○	○
HD Camera Unit (PCSA-CXG80)	○	-
Omnidirectional Microphone (PCS-A1 x 1)	○	-

Distributed by

©2010 Sony Corporation. All rights reserved.
Reproduction in whole or in part without written permissions is prohibited.
Features and specifications are subject to change without notice.
The values for weight and dimension are approximate.
Sony is a registered trademark of Sony Corporation.
IPELA trademarks of Sony Corporation.
All other trademarks are the property of their respective owners.